

Electric Cutting System

XXL2.0



 Read before use



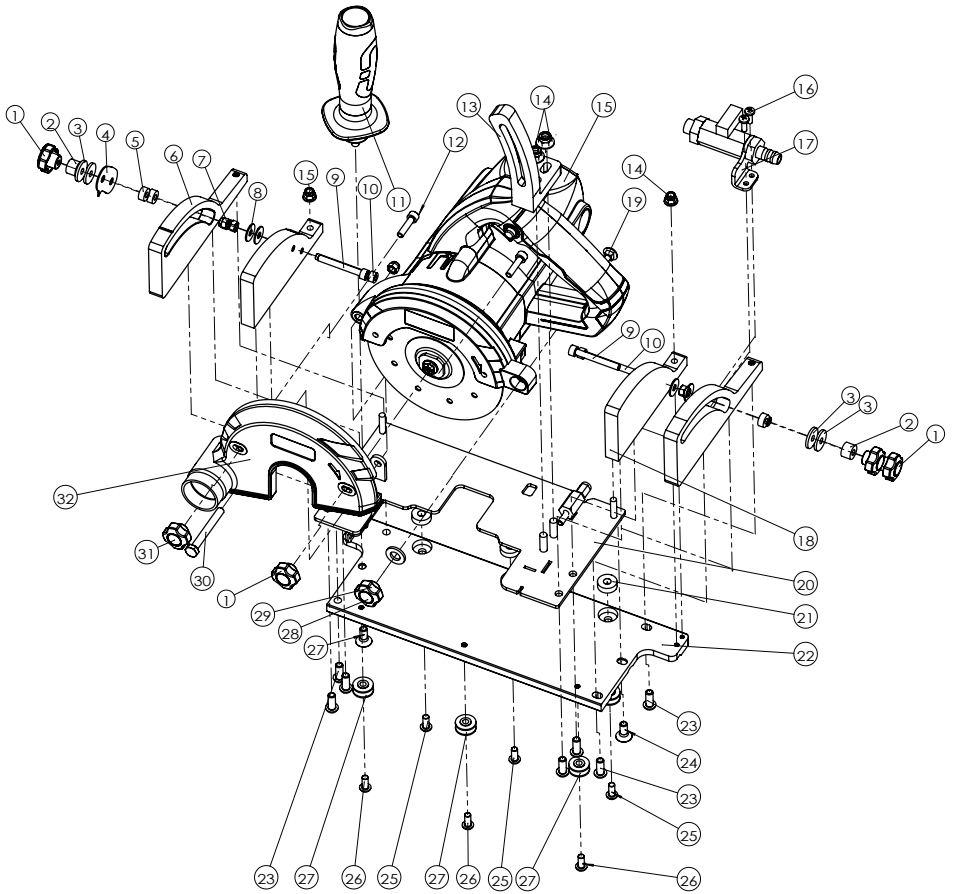

SPARE PART LIST











1	Mini thumb nut,φ26mm	17	water valve fixing parts
2	Insulating post plastic gasket,6x11x10	18	Fixed plate 2
3	M5 gasket	19	Square neck screw,M6*40
4	Pointer piece	20	Base plate sheet metal
5	Bearing	21	U-shaped bearing matching eccentric nut
6	Fixed plate 1	22	Large aluminum plate profile
7	Locknut,M5	23	Pan head hexagon,M6*15
8	M5 gasket	24	Countersunk head hexagon,M6*15
9	Cup head inner hexagon,M5*40	25	U-shaped bearings are equipped with M5 half-thread screws,M5X17
10	Cup head inner hexagon,M5*50	26	Shoulder screw,M4x17
11	Rubberized two-color handle	27	U-shaped bearing
12	Countersunk head hexagon,M5X20	28	End cap
13	Height adjustment	29	Mini PRO hand tightening nut,φ26mm
14	Locknut,M6	30	Grade 12.9 half-thread external hexagonal screws,M6*50
15	marble machine,4510	31	End cap
16	Cup head inner hexagon,M4*10	32	Dust cover,100.6*43

INDEX

- 1 Safety Warnings
- 2 Application
- 3 Assembly and Using Instructions
- 4 Cleaning and Maintenance
- 5 Accessories
- 6 Environmental Protection
- 7 Warranty
- 8 Attachments

Symbols

The following are the icons that are used for the tool. Make sure you fully understand them before using them.

	Read the instruction manual		Wear safety gloves
	CE mark		Wear hearing protectors
	Caution		Wear safety glasses
	Conforms to WEEE		Warning risk of cutting by the saw
	Class II machine		Use of segmented blades prohibited

1. Safety Warnings

⚠ Caution

Read all safety instructions and warnings provided with power tool. Failure to follow the instructions below may result in electric shock, fire and / or serious injury.

Keep all warnings and instructions for future reference.

The term "power tool" used in the safety instructions refers to mains operated power tools (with power cord) or to battery operated tools (without power cord).

General safety warnings for power tools

1.1 Safety in work area

- a) **Keep your work area clean and well lit.** Disarray or unlit work areas can lead to accidents.
- b) **Do not work with the power tool in a potentially explosive environment in which flammable liquids, gases or dusts are present.** Power tools generate sparks that can ignite the dust or fumes.
- c) **Keep children and bystanders away while using the power tool.** Distractions can result in a loss of control.

1.2 Electrical Safety

- a) **The plug of the power tool must fit into the socket. The plug must not be changed in any way.** Do not use adapter plugs together with electrically grounded power tools. Unmodified plugs and matching sockets reduce the risk of electric shock.
- b) **Avoid body contact with grounded surfaces such as pipes, heaters, stoves, and refrigerators.** There is an increased risk of electric shock if your body is grounded.
- c) **Keep power tools away from rain or moisture.** The penetration of water into a power tool increases the risk of electric shock.
- d) **Do not misuse the power cord to carry the power tool, hang it up, or unplug it from the power outlet.** Keep the connection cable away from heat, oil, sharp edges or moving parts. Damaged or entangled leads increase the risk of electric shock.
- e) **When working outdoors with a power tool, only use extension cables that are also suitable for outdoor use.** Using an extension cord suitable for outdoor use reduces the risk of electric shock.
- f) **If operation of the power tool in a damp environment is unavoidable, use a residual current device.** Using a residual current circuit breaker reduces the risk of electric shock.

1.3 Personal Safety

- a) **Be attentive, pay attention to what you are doing and be reasonable about working with a power tool. Do not use a power tool when you are tired or under the influence of drugs, alcohol or medication.** A moment of carelessness when using the power tool can cause serious injury.
- b) **Wear personal protective equipment and always safety goggles.** Wearing personal protective equipment such as a dust mask, non-slip safety shoes, hard hat or ear protection, depending on the type and use of the power tool, reduces the risk of personal injury.
- c) **Avoid unintentional startup. Make sure that the power tool is switched off before connecting, receiving or carrying it to the power supply and / or the battery.** Keeping your finger on the switch when you are wearing the power tool or plugging the power tool into power can cause an accident.
- d) **Remove setting tools or wrenches before turning on the power tool.** A tool or key located in a rotating part of the power tool can cause injury.
- e) **Avoid an abnormal posture. Ensure a secure footing and maintain balance at all times.** This allows you to better control the power tool in unexpected situations.
- f) **Wear suitable clothing. Do not wear loose clothing or jewelry.** Keep hair and clothing away from moving parts. Loose clothing, jewelry or long hair can be caught by moving parts.
- g) **If dust extraction and collection equipment can be installed, they must be connected and used properly.** Using a dust extractor can reduce dust hazards.
- h) **Do not weigh yourself in false safety and do not overstep the safety rules for power tools, even if you are familiar with the power tool after many uses.** Careless action can lead to serious injuries within fractions of a second.

1.4 Use and care of the power tool

- a) **Do not overload the power tool. Use the appropriate power tool for your work.** With the right power tool you work better and safer in the specified power range.
- b) **Do not use a power tool whose switch is defective.** A power tool that can not be turned on or off is dangerous and must be repaired.
- c) **Unplug the power cord and / or remove a detachable battery before making any adjustments to the device, changing the tool bits, or putting the power tool away.** This precaution prevents the unintentional start of the power tool.
- d) **Store unused power tools out of the reach of children. Do not allow persons to use the power tool that are unfamiliar or have not read these instructions.** Power tools are dangerous when used by inexperienced people.
- e) **Maintain power tools and insert tools with care. Check that moving parts are working properly and do not jam, that parts are broken or damaged enough to impair the functioning of the power tool. Have damaged parts repaired before using the power tool.** Many accidents are caused by badly maintained power tools.
- f) **Keep cutting tools sharp and clean.** Carefully maintained cutting tools with sharp cutting edges become less jammed and easier to guide.
- g) **Use power tools, accessories, tools etc. according to these instructions. Take into account the working conditions and the activity to be performed.** The use of power tools for other than intended applications can lead to dangerous situations.
- h) **Keep handles and grips dry, clean and free of oil and grease.** Slippery handles and gripping surfaces do not allow safe operation and control of the power tool in unforeseen situations.

1.5 Use and care of the battery tool

- a) **Charge the batteries only with chargers recommended by the manufacturer.** A charger suitable for a particular type of battery may cause a fire when used with other batteries.
- b) **Use only the appropriate batteries in the power tools.** Use of other batteries may cause injury or fire.
- c) **Keep the unused battery away from paper clips, coins, keys, nails, screws, or other small metal objects that could cause the contacts to bridge.** A short circuit between the battery contacts can cause burns or fire.
- d) **If used incorrectly, liquid may leak from the battery. Avoid contact with it. In case of accidental contact, rinse with water. If the fluid gets into your eyes, seek additional medical attention.** Leaking battery fluid may cause skin irritation or burns.
- e) **Do not use a damaged or modified battery.** Damaged or altered batteries can behave unpredictably and cause fire, explosion or injury.
- f) **Do not expose a battery to fire or high temperatures.** Fire or temperatures over 130 ° C can cause an explosion.
- g) **Follow all charging instructions and never charge the battery or the cordless tool outside the temperature range specified in the operating instructions.** Incorrect charging or charging outside the permitted temperature range can destroy the battery and increase the risk of fire.

1.6 Service

- a) **Only have your power tool repaired by qualified personnel and only with original spare parts.** This ensures that the safety of the power tool is maintained.
- b) **Never use damaged batteries.** All battery maintenance should only be done by the manufacturer or authorized service centers. Follow the instructions for lubricating and changing accessories.

Additional safety warnings from the manufacturer

The following are the safety precautions when using the stone cutting machine, please be sure to strictly observe it, otherwise it may damage the tool or damage the body.

- Before use, please check that the cutting blades should be free of cracks or damages. Do not use damaged, deformed or cracked cutting blades.
- Do not use grinding wheels and diamond cutting discs that do not meet the performance specified in the instructions.
- The upper and lower pressure plates and wrenches configured by this tool must be used
- As an extra protection against electric shock, it is best to wear rubber gloves and rubber boots during operation.
- For the cutting machine with residual current action protector, the operation reliability of the residual current action protector should be checked before operation.
- Before cutting, check and confirm that the depth adjustment bolts, angle adjustment bolts, and hexagon bolts that fasten the cutting blades are tightened.
- Do not run with the fixed shield removed, and do not touch the underside of the workpiece. The shield cannot protect the saw blade under the workpiece.
- When starting the tool, it should be checked to ensure that the cutting blade is not in contact with the workpiece or any other objects. The cutting machine must not be started when the cutting blade is in contact with the workpiece.
- Do not touch the rotating parts with your hands, keep your hands away from the sawing area and diamond blades. Always hold the auxiliary handle with your other hand.- Hold the tool firmly during operation. When the cutting blade suddenly slows down or gets stuck by the workpiece, release the switch in time.
- It is forbidden to use a vise or a jig to clamp the tool and cut on it.
- After the cutting machine is powered off, do not put down the cutting machine before the cutting piece is completely stopped, and do not use any external force to force the cutting piece to stop.
- Before replacing the cutting blade, adjusting the cutting depth, or servicing the cutting machine, the plug should be disconnected from the power supply, and the cutting blade is at rest.
- When operating in a place where the diamond saw blade may cut into dark wires or its own wires, the power tool can only be held by the insulating holding surface. Turning the diamond saw blade to the live wire may charge the exposed metal parts of the power tool and expose the operator to electric shock.
- Be very careful when making "blind cuts" into walls or other blind areas. Diamond saw blades may cut gas pipes or water pipes, wires or objects that cause rebound.
- Always use diamond saw blades with proper size and axis shape (diamond or round). If the diamond saw blade does not match the cutting machine clamping parts, it will cause eccentric operation and cause runaway.
- Do not use damaged washers and bolts that do not match the size.

Using damaged or non-conforming washers and bolts can lead to uncontrolled operation.

2. Application

- Suitable for cutting tiles size upto 3.2M; Rails in size 1.4M and 0.8M for different tiles.
- Featured with 90degree and 45degree cutting.
- Dry cutting with dust extractor hood and adaptor to the vacuum machine.
- Max. Cutting depth 17mm.
- Compatible rails with the manual cutting system. Two system, One rail.

Voltage/Frequency	230V/50Hz
Input Power	1500W
No Load speed	13000/min
Accessories	3pcs spanner, 1set carbon brush, 1pc rubber adaptor Edge cutting blade

Manufacturer reserves the right to change specifications without notice.
Specifications may differ from country to country

3. Assembly and Using Instructions

3.1 Rail Connection

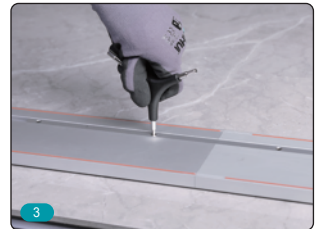

3.2 90° Straight cutting

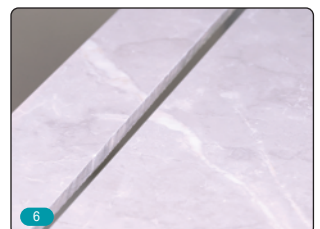
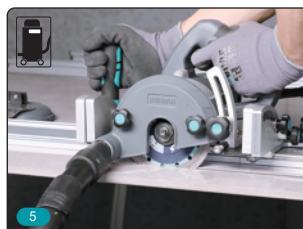
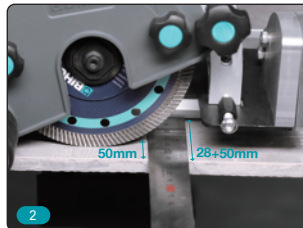

3.3 45° Mitre cutting



Fig 1

3.4 Install or Uninstall Blade

- Loose the screw to remove the dust cover (Fig 1)

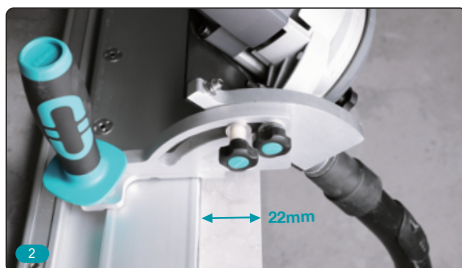

Fig 2

- Fix the upper pressure plate with an open wrench, turn the socket wrench clockwise to loosen the hexagon bolts, remove the bolts, and upper pressure plate to remove the cutting piece. When installing the cutting blade, the direction shown by the arrow on the surface of the cutting blade should be the same as the direction of the tool_up arrow, and then the installation should be reversed in the above order. (Fig 2 and Fig 3)



Fig 3

⚠ Caution

- The hex bolt must be tightened, and this bolt is left-handed.



Fig 4

3.5 Adjust Cutting Depth

- Loosen the quick-lock handle downward to pull the bottom plate and adjust the machine to the desired depth. (Fig 4)

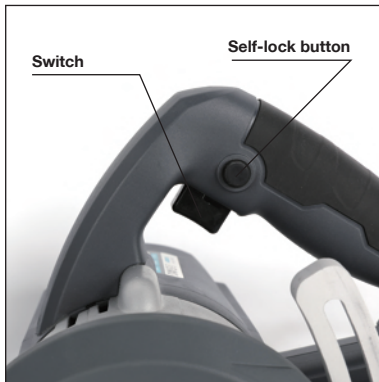

Fig 5

3.6 Switch and Self-lock Button

- Before inserting the plug into the power supply, you must confirm that the self-locking button of the switch is in the released state and the switch is in the off position.

- Press the switch trigger to start the tool and release the trigger completely, the tool is in the closed state. If you need to lock the switch, press the switch trigger and press the self-locking button, the tool will continue to run, then pull the trigger and release it completely, you can make the tool in the closed state. (Fig 5)



Fig 6

3.7 Replace Carbon Brush

⚠ Caution

- Unplug the power plug before replacing the brush.

- When large sparks occur or the tool stops when the tool is running, the brush should be replaced.

- When replacing, use a screwdriver to unscrew the brush cover, remove the worn brush, install the new brush, and test the brush by hand to confirm that it can slide freely in the slot, then install, and tighten the brush cover.

- The brushes are required replaced at the same time. (Fig 6)

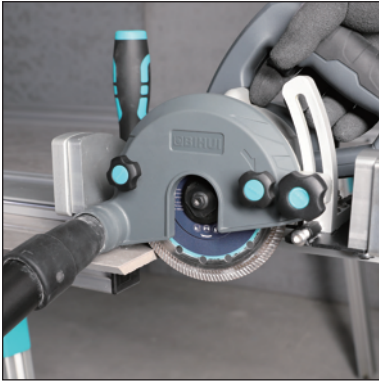

Fig 7

3.8 Effective and Safe Cutting Method

- Hold the tool firmly, place the tool bottom plate on the workpiece to be cut without any contact with the cutting blade, and then start the tool and wait for it to obtain the maximum speed, then you can simply move the tool forward along the surface of the workpiece. Please keep it level and move forward slowly until the cutting is completed. Please keep the cutting line consistent and the forward speed uniform. After cutting, let the tool idle for 1 ~ 2 minutes to remove the dust in the tool. (Fig 7)

4. Cleaning and Maintenance

⚠ Caution

- Always be sure that the tool is switch off and unplugging before attempting to perform inspection and maintenance.
- The tool and its air vents have to be kept clean, regularly clean the tool's air vents or whenever the vents start to become obstructed.
- Frequently remove tools, debris, oil and other undesirable attachments to keep tools clean and sharp.
- Always check that there are no loose screws in the connecting parts, and the outer shell should be free of cracks and defects.
- Always check that the insulation of the power cord is not damaged.

5. Accessories

This accessory is recommended for use with your device specified in this manual.

- Using other accessories or attachments may result in personal injury. Only use accessories or accessories for the stated purpose.
 - For more information about this accessory, contact the local distributor.
- a) Three different spanner.
 - b) One set of carbon brush.
 - c) Rubber adaptor.

6. Environmental Protection

- Do not dispose of electrical appliances in the household waste.
- Follow the local provisions for the disposal of electrical or battery products.
- Valuable materials can be recovered by recycling.
- The electrical or battery components used for construction are in accordance with the regulation European Directive 2012/19 / EU on waste electrical and electronic equipment and transposition into national law., used electrical appliances must be collected separately and recycled in an environmentally sound manner.
- Contact us for further information.



7. Warranty

- The guarantee covers all manufacturing or assembly defects in accordance with the legislation in force. The guarantee does not cover malfunctions caused by improper use, overloads, failure to follow the operating instructions and normal wear and tear.
- For more details and information, consult the general guarantee conditions at www.bihutools.com.

8. Attachments

CE Declaration of Conformity



www.bihuitools.com